

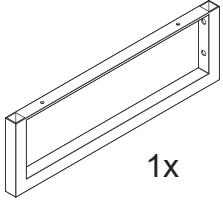

## 83283

 1x	 2x	 2x	 2x	 2x	Mitgeliefertes Befestigungsmaterial ist nur für Beton B25 geeignet.
-----------------------------------------------------------------------------------------	-----------------------------------------------------------------------------------------	-----------------------------------------------------------------------------------------	-----------------------------------------------------------------------------------------	-------------------------------------------------------------------------------------------	---------------------------------------------------------------------

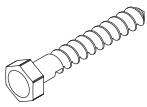
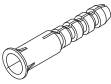

\*Maße sind vor Ort zu prüfen

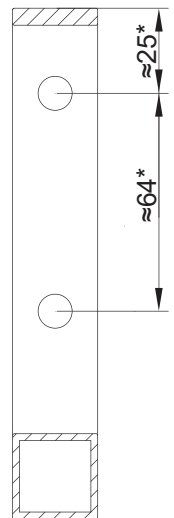
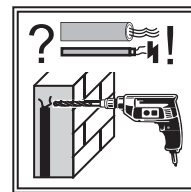
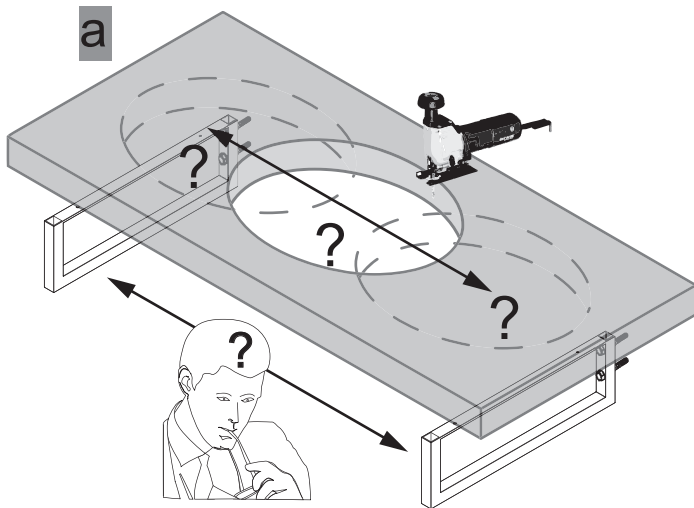
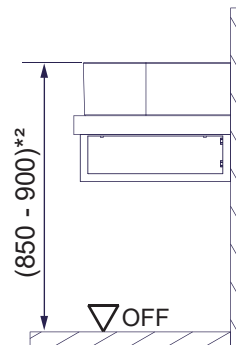

\*2Höhenmaß abhängig von verwendetem Becken

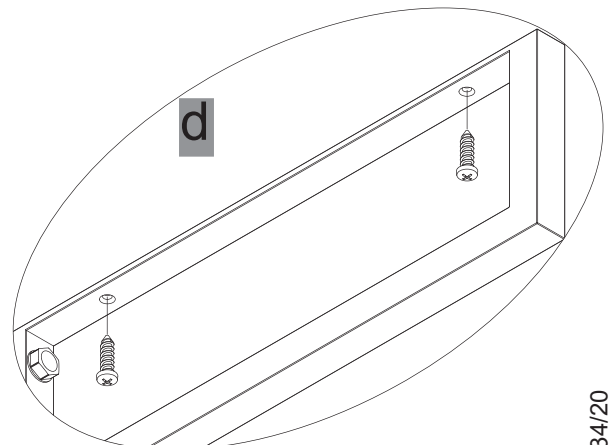
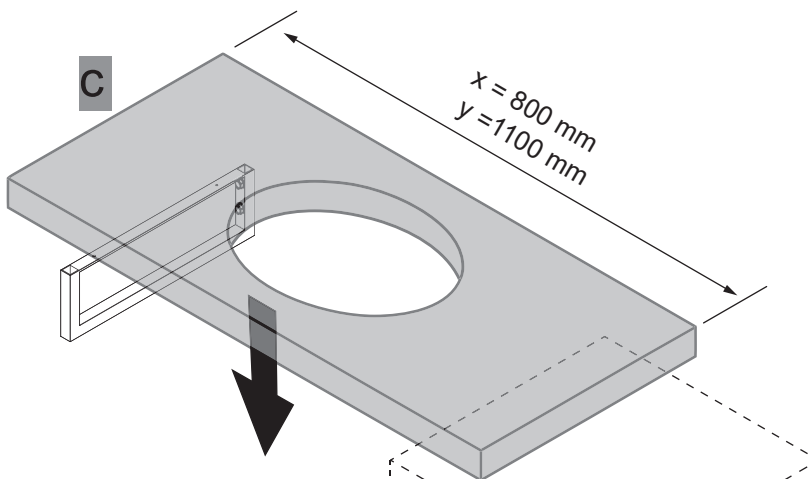
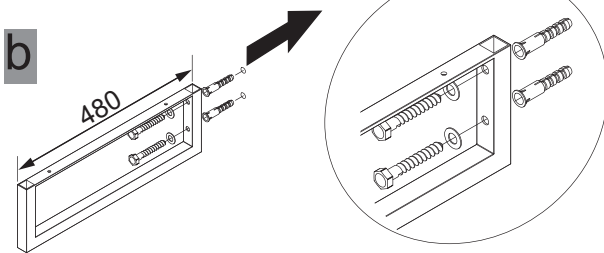

**FACKELMANN®** GmbH + Co. KG  
 Sebastian-Fackelmann-Str. 6  
 91217 Hersbruck • Deutschland  
 FAX: 09151/811-294  
 Servicetelefon: 09151/811-206  
 servicebm@fackelmann.de  
 www.fackelmann.de

